



# 1962 - 1965 Fairlane

Installation Guide

# Table of Contents

- Required tools
- Kit contents
- Motor Orientation Diagram
- Steering column and wheel removal
- Steering box modifications and adaptations
- Steering column modifications
  - disassembly
  - cut lengths
  - wire exit relocation
- Bearing plate installation
- Firewall plate installation
- Column and motor reassembly
- Column staking guide
- Lower portion installation
- Module and potentiometer installation
- Wiring diagram
- Warranty and product disclaimer

## WARNING



**Please read and understand this manual before installing your EPAS kit.**

The installation of this system should be done by a professional mechanic or a very knowledgeable amateur. You will be cutting and splicing your steering column, therefore EPAS Performance will not be held responsible for any malpractice. Caution should be taken when installing the electric motor: no impacts, shocks or hammering should be done to the unit. For aesthetic reason, you may choose to paint the assembly either in black or the color of your steering column to conserve the original look.

For a complete understanding, we strongly suggest to read this owner's manual prior to any installation.

**Should you have any questions or concerns feel free to contact us at (941) 893-5427 or visit our website for installation videos.**

EPAS Performance wishes you thousands of enjoyable miles with your new Electric Power Steering!



### Required tools:

- Drill
- Right angle grinder, with cutting disc
- Eye protection
- Measuring tape
- Steering wheel removal tool
- You will also need hand tools to remove the steering column

# Fairlane 1962 - 1965



# Motor Orientation Diagram

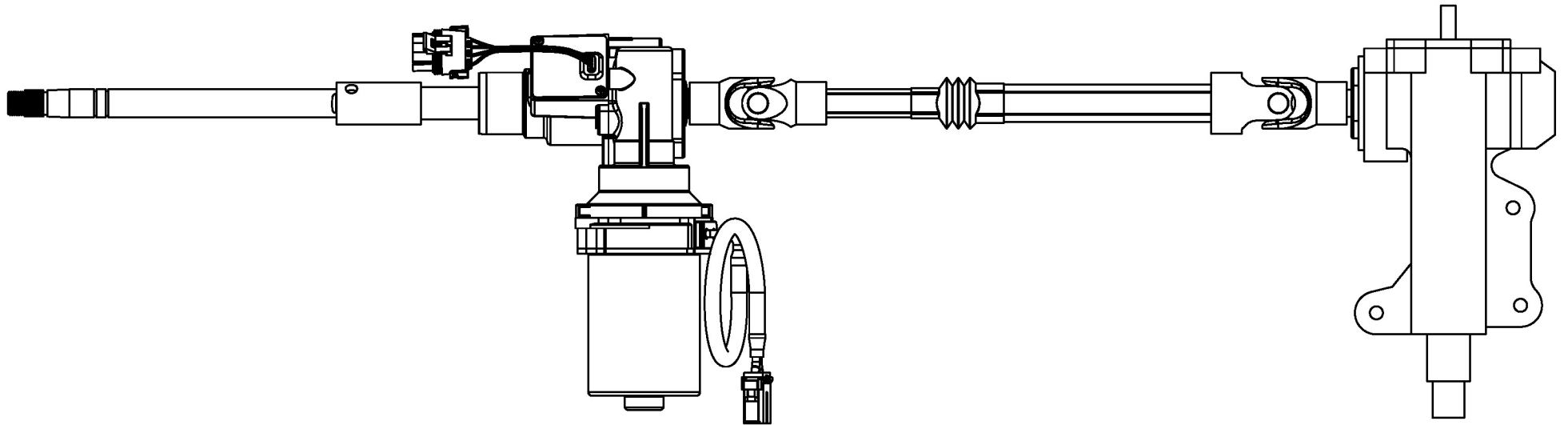

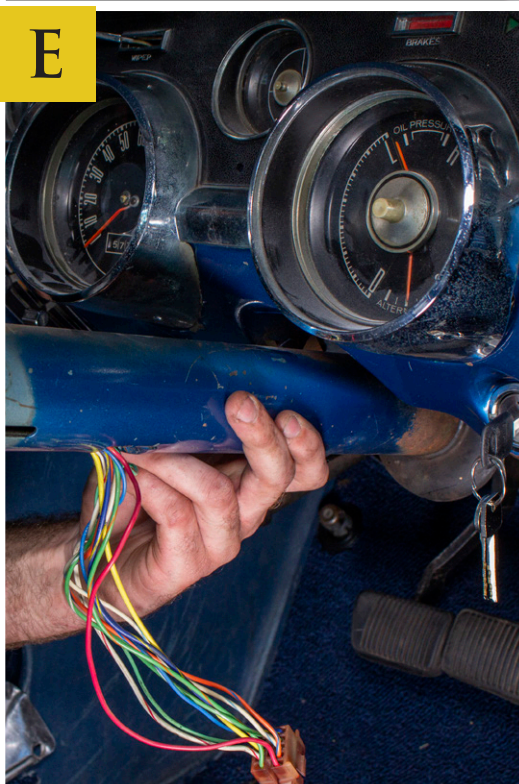

## Remove Column & Steering Wheel:

To begin the install you will need to disassemble and remove the steering wheel and column tube.

Use the appropriate tool to remove the steering wheel. Unplug the wiring harness from the vehicle. Remove the column bracket. Remove the four bolts holding the steering column and floor seal in place. Pull the steering column free.

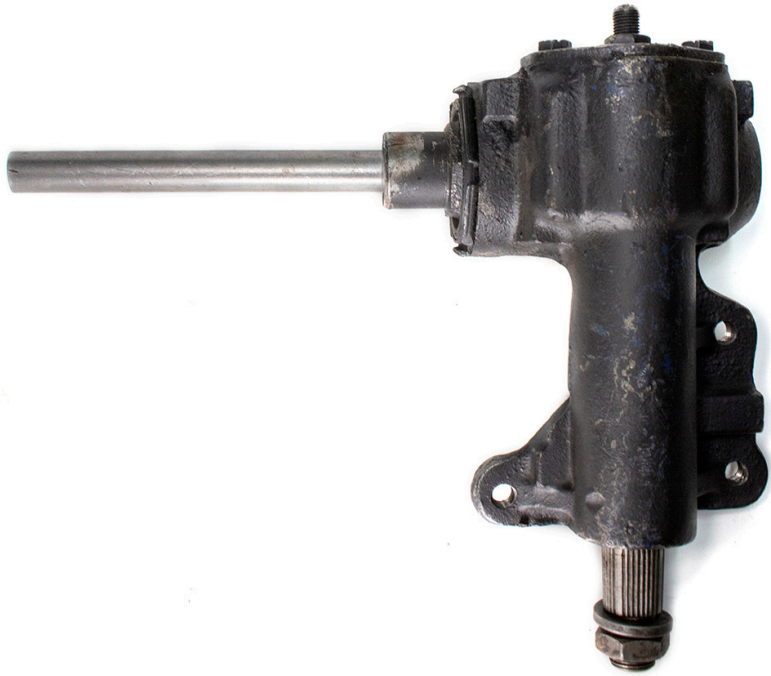
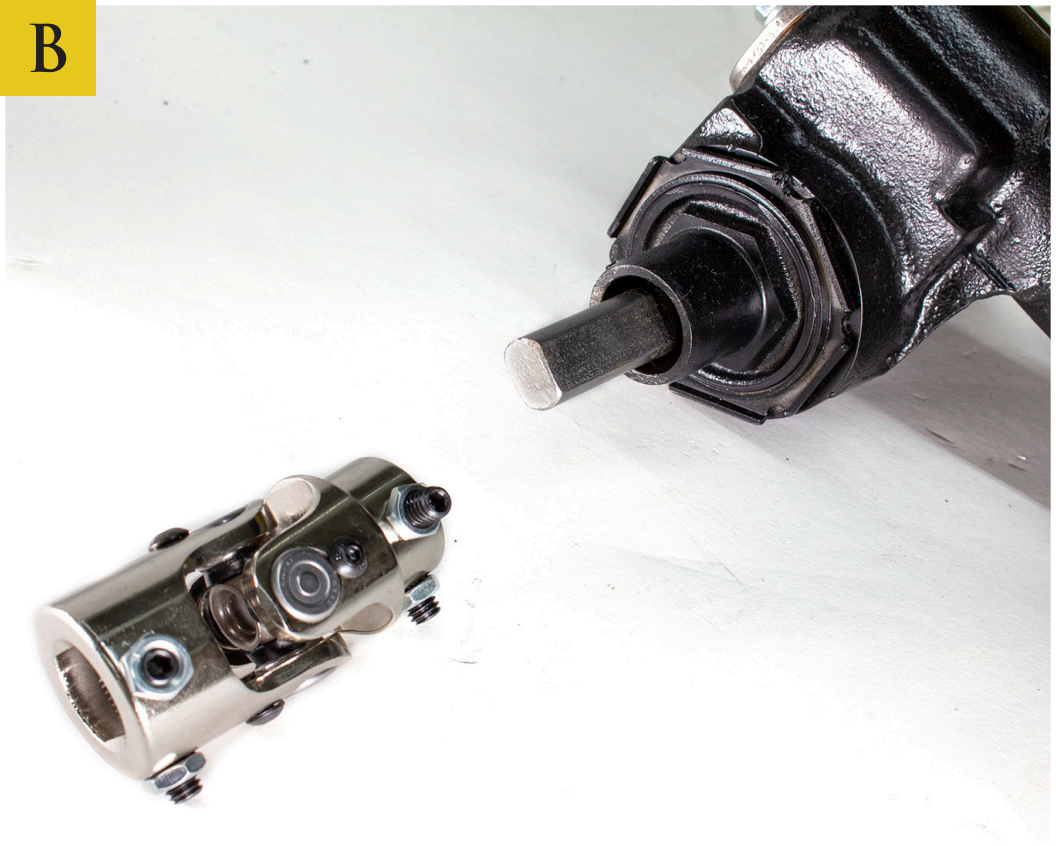
**A****B**

## Shaft & Steering Box Modifications:

Once the column tube is free, cut the steering shaft at the firewall (engine bay side) to allow easy removal of the steering box. The rest of the steering shaft will be replaced by the provided shaft in your EPAS Performance kit. OEM Steering shaft can be discarded.

You will need to mill 0.105" from both sides of the shaft closest to the steering box housing to create a 2" long DD section. Once the shaft has been modified you can cut it to its final length of 1 ½".

Once the shaft has been modified the steering box can be reinstalled in the vehicle.

Connect the supplied U-Joint to the end of the steering box shaft.

## Additional Option:

- You can purchase a rebuilt steering box from us which already has a DD shaft end. (The steering box program works on an exchange basis with a refundable core charge upon receiving your original steering box.)

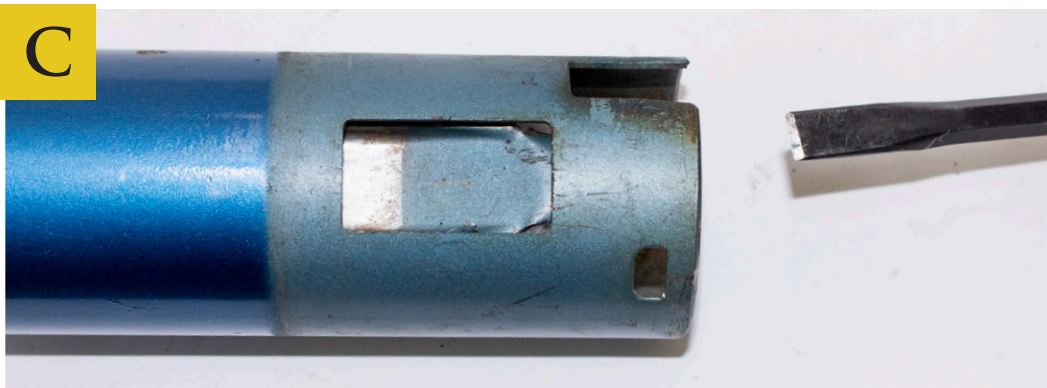
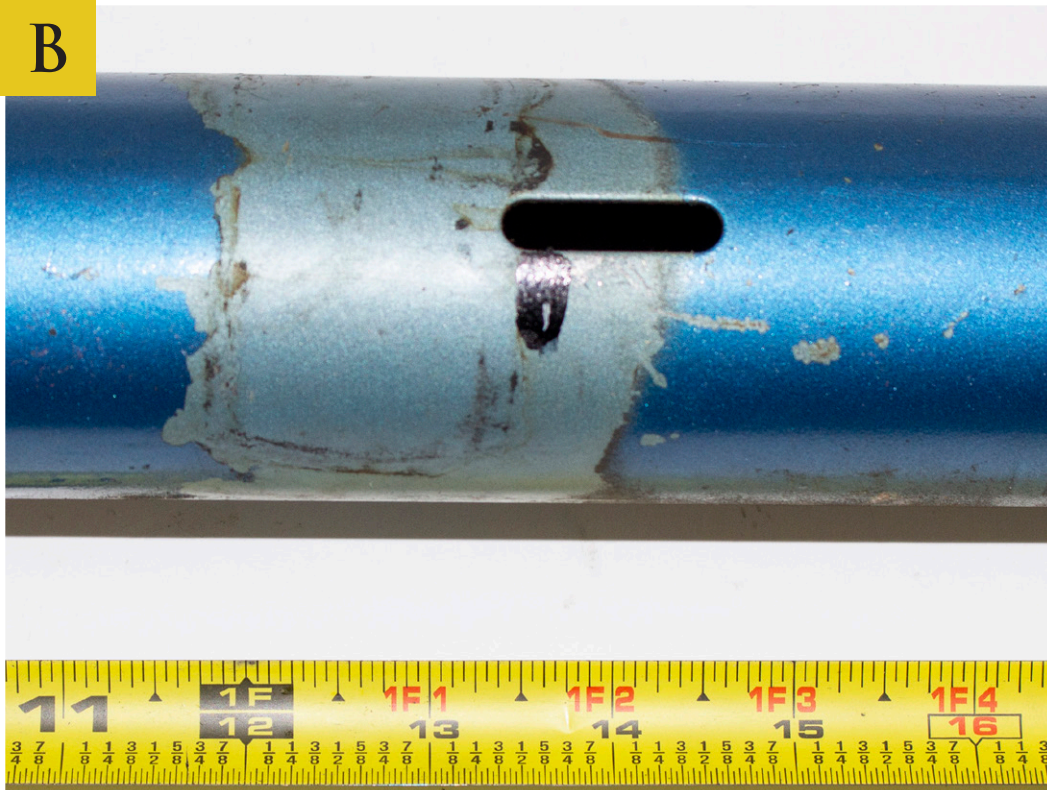
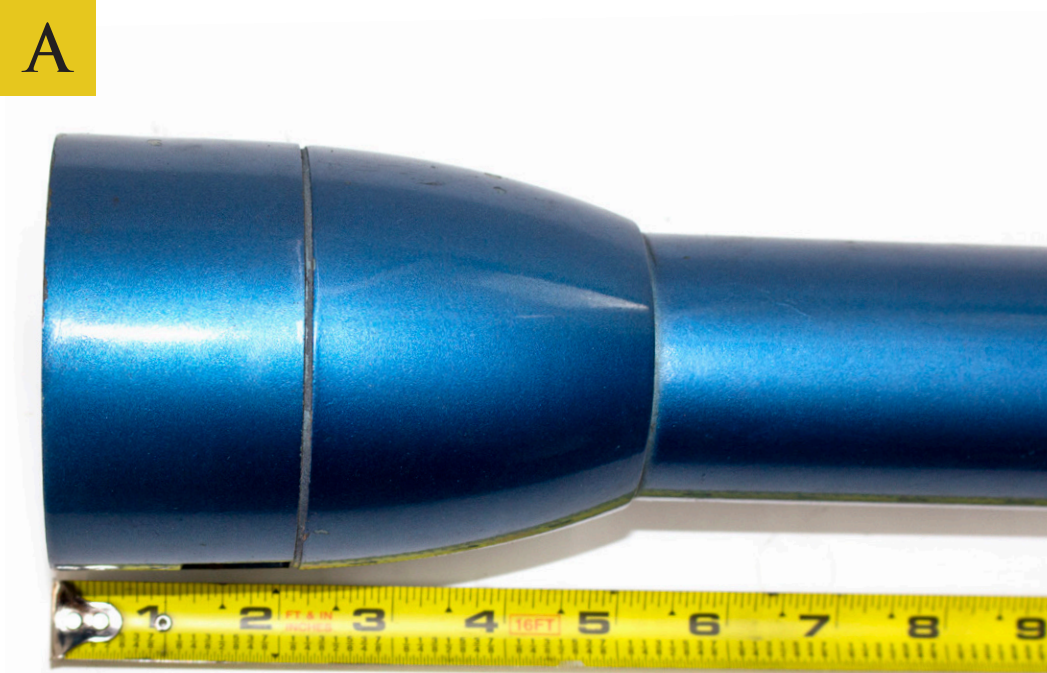

## Column Modifications:

Precut IDIDIT Tilt Columns are available if you do not want to modify or otherwise use your OEM column.

Measuring from the top of the column where the steering wheel mounts, mark the column at 13 ½" **BEFORE DISASSEMBLY.**

Remove the column bell and internal wiring harness from the column. Carefully remove the wiring trough from the column.

*\*If you have purchased the precut premodified IDIDIT tilt column from us you can safely skip this section.*



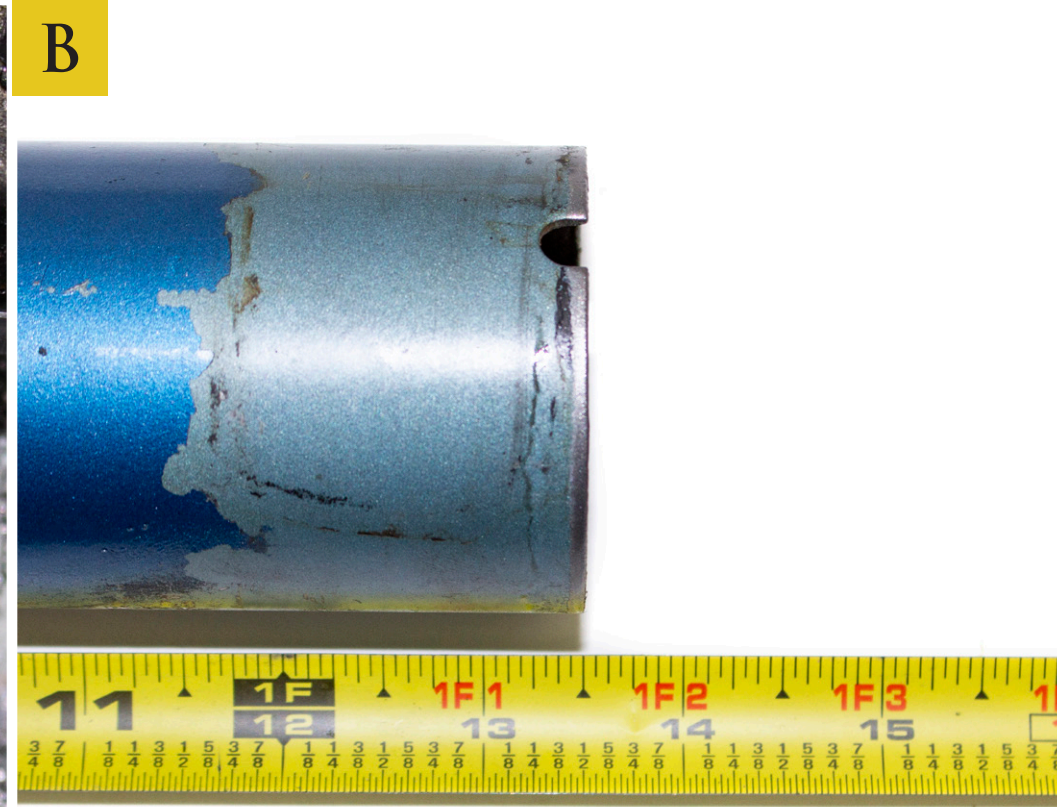

## Column Modifications:

Once the column is fully disassembled, cut the tube at previously marked length (13 1/2”).

This will leave just enough room for the U clamp to hold properly to the steering column. When using the aftermarket IDIDIT tilt column, the OEM U-clamp has a tab that fits into the original column that will need to be removed.

***\*If you have purchased the precut premodified IDIDIT tilt column from us you can safely skip this section.***

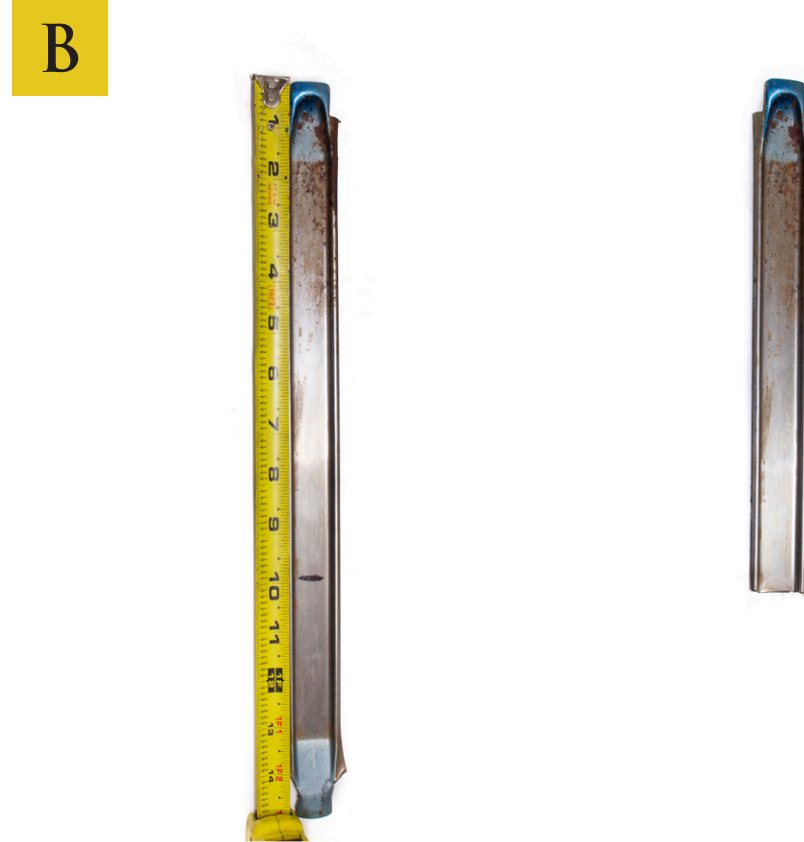

## Column Modifications:

Measure 11" from the steering wheel side of the column tube, mill a 2" by 1" hole. Ensure the milled hole is in line with the original wire exit.

Replace the wire trough into the column tube and mark the end point of the new hole on the trough. Cut the wire trough at the marked point. Reweld the wire trough in place.

Once all column modifications are complete reassemble the column bell housing and inner wiring harness.

**A****B**

### Bearing Plate Assembly:

When installing the firewall and bearing flanges, align them so that they match the images shown. Be sure the three bolts holding the bearing in place are loose to allow the bearing to pivot inside of the flanges. This will allow you to achieve the required angle of the collapsible shaft to align with the steering box (mounting flanges may have to be separated for bearing to pivot).



## Firewall Plate Installation:

Use the OEM bolts that held the original floor seal to fasten the replacement firewall plate provided in the EPAS kit.

The bearing on the firewall plate should face the engine bay side.

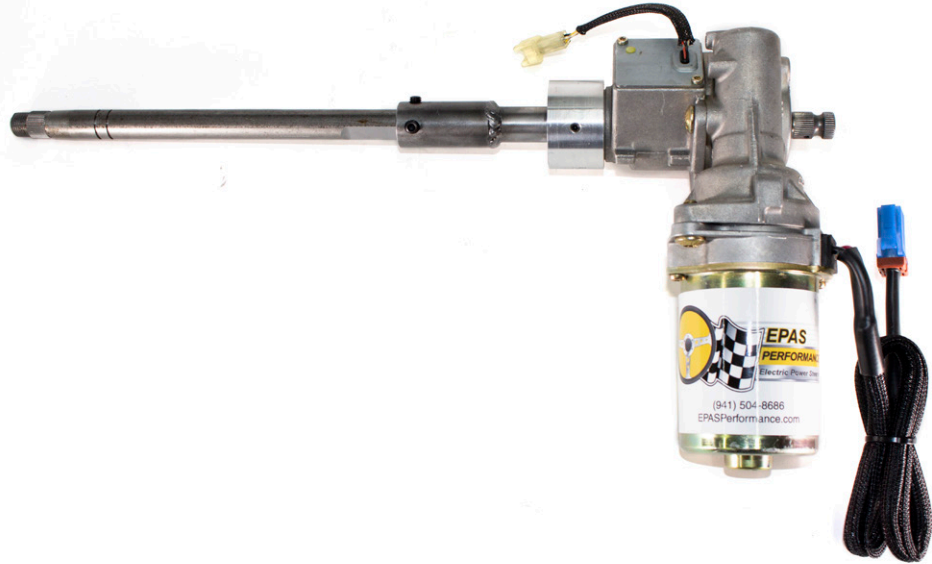
**A****B****C**

## Column and Motor Assembly:

Begin assembly by installing the provided steering shaft into the EPAS motor, you will need to remove the nut on the shaft. Once the shaft is fully seated, tighten and locktite the set screws on the motor coupler. Place the column tube over the steering shaft and aluminum coupler on the EPAS Performance motor. Place the provided U-Joint on the splined end of the motor and tighten the set screws to fix it in place. Setscrews should be seated in the section between the two sets of splines. Improper installation will cause the system to bind.

Once fully assembled, the motor and column assembly can be placed into the vehicle and fixed in place using the OEM column bracket. When using the aftermarket IDIDIT tilt column, the OEM U-clamp has a tab that fits into the original column that will need to be removed.

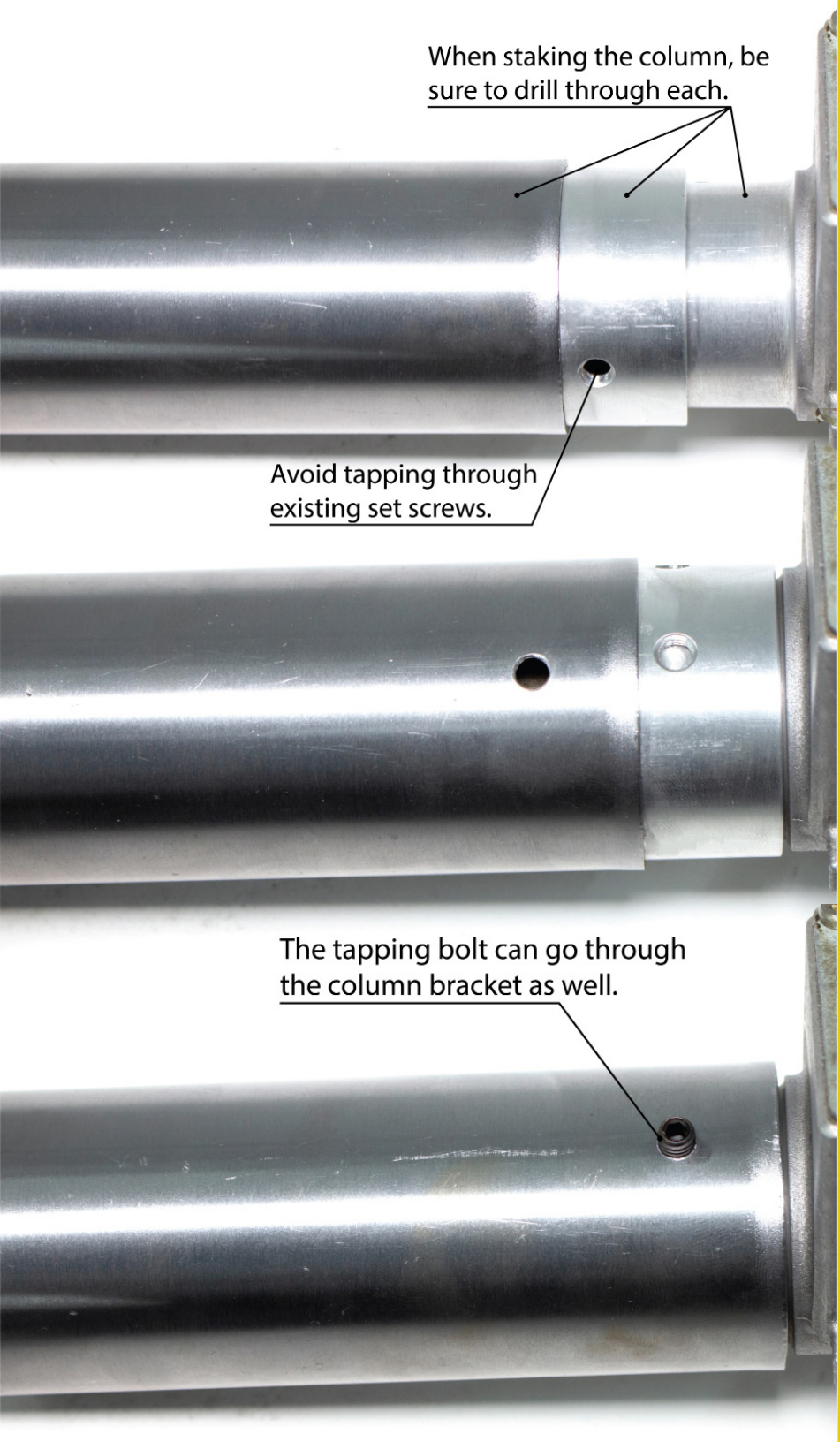

When staking the column, be sure to drill through each.

Avoid tapping through existing set screws.

The tapping bolt can go through the column bracket as well.

## STAKING COLUMN:

For added stability, the column tube and motor housing can be “staked” in place to reduce the possibility of the system spinning in the vehicle. This process is suggested but not required.

To begin the staking process you will first need to clock the motor to the correct position and mark the column. Once the steering column is in place, the motor should sit between 9 and 11 O’clock position. The motor has 360° clockability to allow for an adjustable fit if the suggested position does not work.

Drill a hole through the column tube and the aluminum collar (attached to the motor) tapping the motor housing. (“Tapping” the motor housing is making a dent in the housing to ensure the bolt being used will rest in the dent) Stake the column in place using ¼-20 bolt to “sandwich” all three together.

Ensure the screw length is no more than 10mm, if it is too long it can bind the shaft. You can drill through the motor housing for additional security **(BE SURE NOT TO DRILL OR TAP INTO THE MOTOR SHAFT)**.

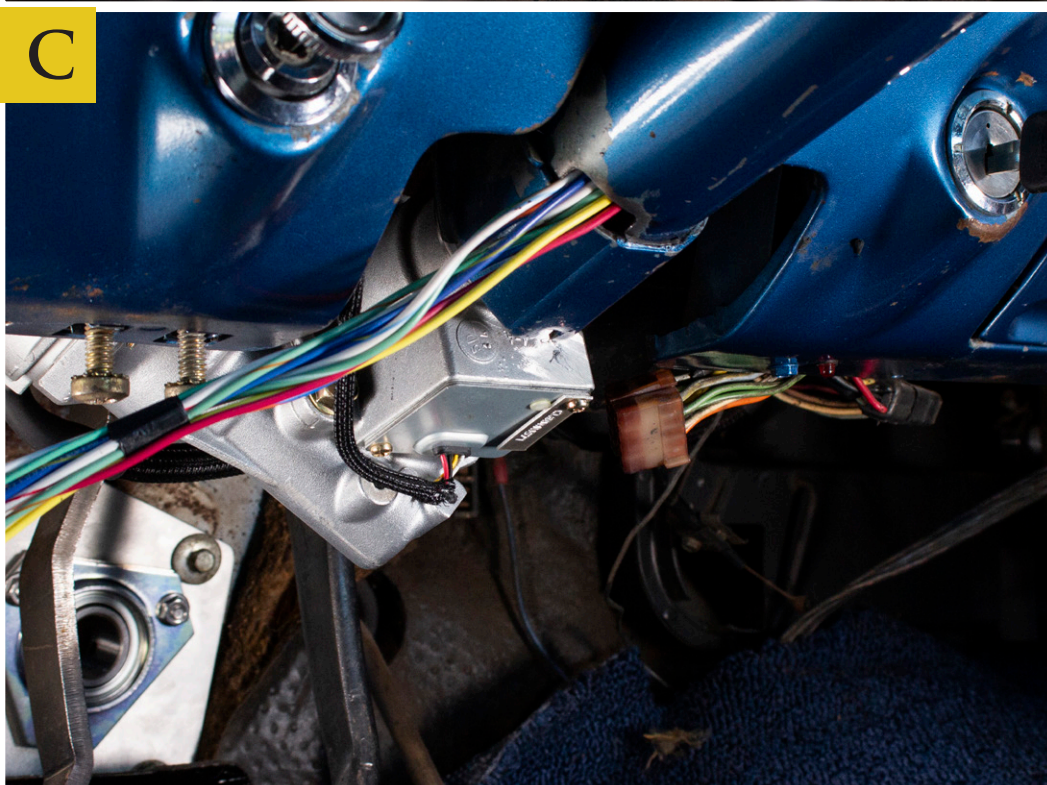
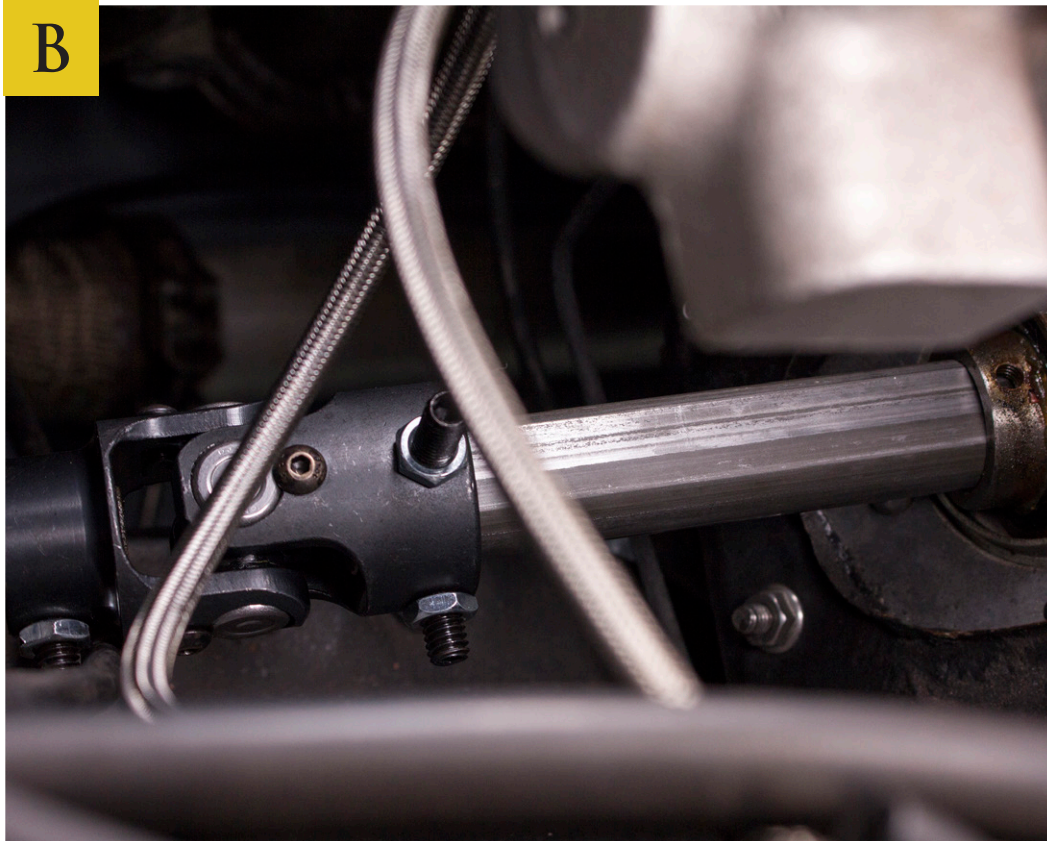

### Lower Portion Installation:

Place the provided U-Joint on the steering box or rack shaft, if equipped. Pull the 1"DD shaft of the provided collapsible shaft through the firewall bearing and fit the 3/4"DD shaft into the U-Joint on the rear of the motor.

Make sure to tighten all bolts and set screws once the parts are aligned. Ensure set screws are seated properly to prevent binding.

Some U-Joint manufacturers may provide one longer set screw. This set screw does not need to be shortened and can be used as provided.

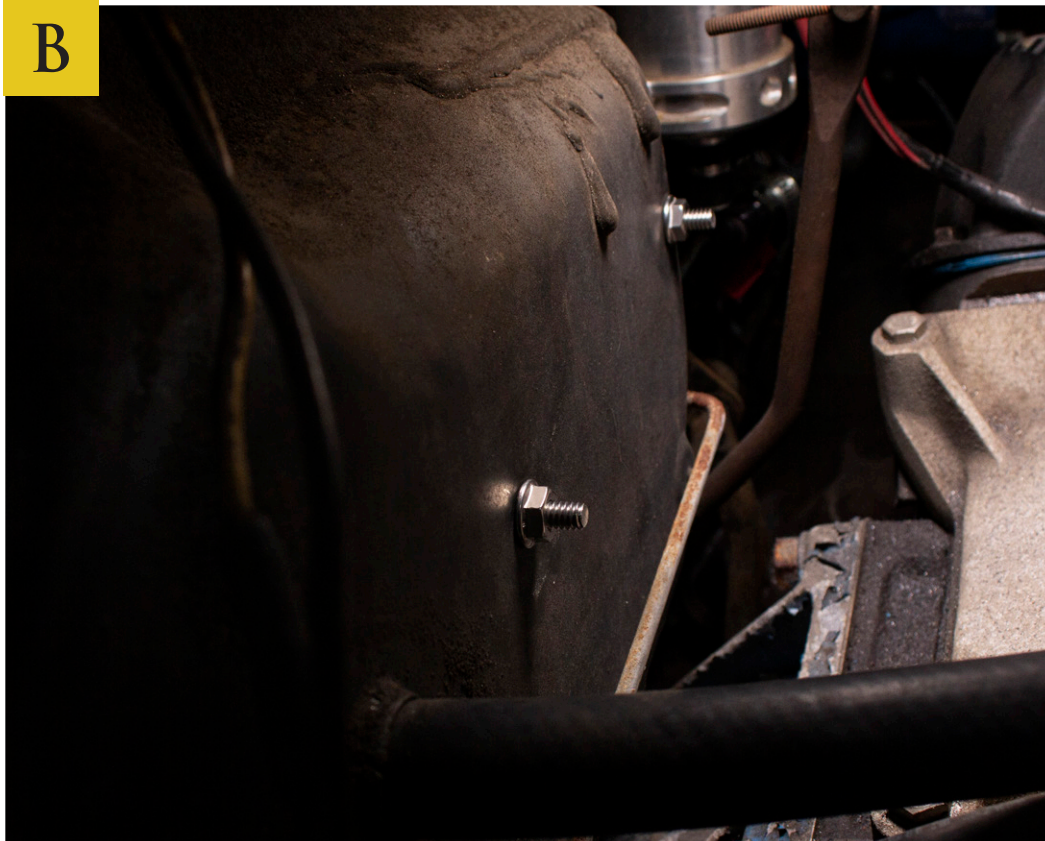

## Control Module Installation:

Install the pre-wired control module and its wiring. Location inside the vehicle is at builders discretion. Photo above is the suggested location (on the firewall behind the heater controls).

Ensure both ground wires are properly connected to the module plate before mounting.

Connect the plug from the motor (**Blue Connector**) to the module. Connect the plug for the torque sensor (**4way**) to the module.



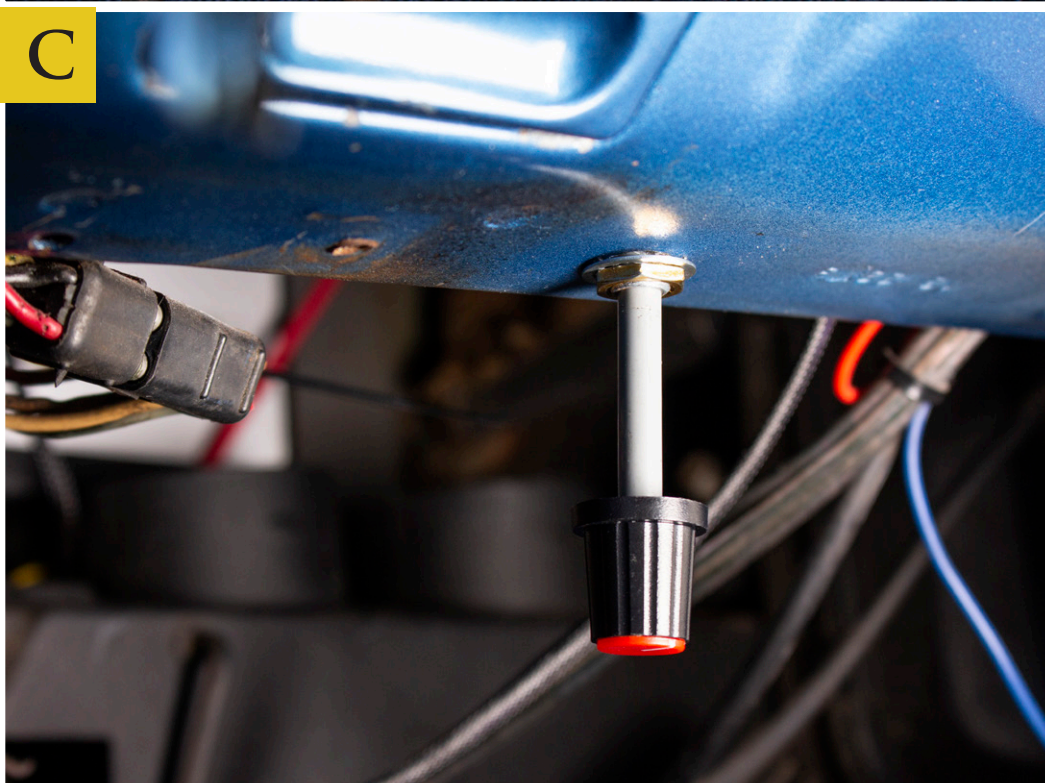

## Power Wires & Potentiometer Installation:

Reconnect the column wiring harness to the vehicle. If a precut premodified IDIDIT tilt column has been purchased instructions on column harness plug assembly are included. Be sure to replace the OEM plug to match.

Hook up the small red wire to a hot in run and the #10 red wire directly to your battery or a direct power source.

Install potentiometer in an accessible location. This potentiometer allows you to adjust the strength of the assistance provided by the system. When turned fully clockwise the system will be set to maximum. Turning the dial counter clockwise will reduce the amount of assistance until none is being provided. Your steering will have returned to its original resistance; however, the system will not be completely powered down until the vehicle itself is turned off.

# Module Wiring Diagram

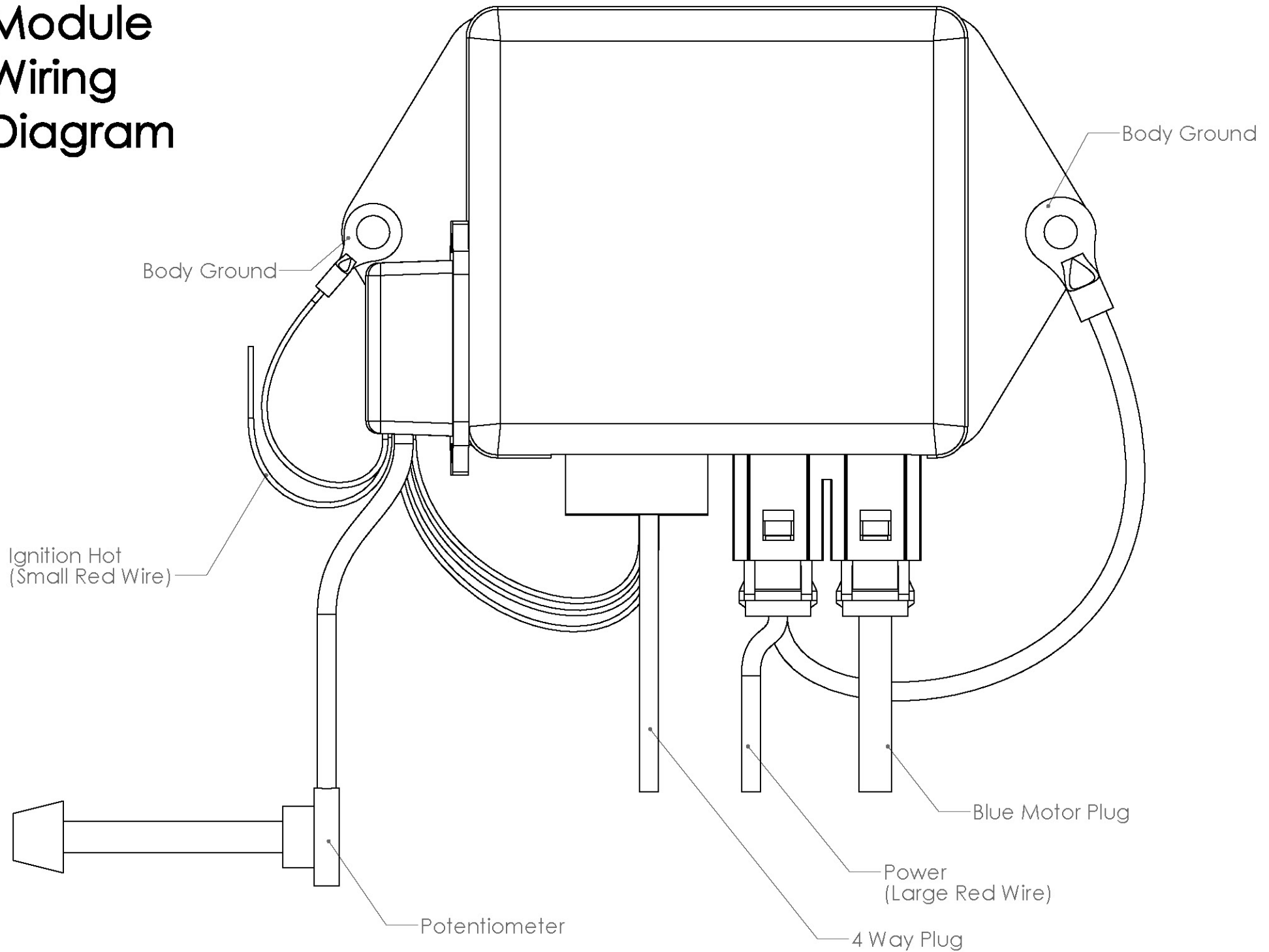

# TERMS AND CONDITIONS

## LIABILITY LIMITATION AND RELEASE

We are pleased you have chosen to purchase one of our automotive specialty equipment items. Our products are carefully designed to combine performance, durability and safety, and to work in concert with the vehicle's original equipment. As they are specialty products, however, and as both performance and safety are paramount concerns, we urge our customers to consider having the products professionally installed.

We caution the purchaser that the enhancement provided by the specialty equipment item may change the handling characteristics of the vehicle. We urge the purchaser to carefully familiarize him/herself with the vehicle's performance characteristics with the new equipment. This should be done in a safe environment and in a safe manner.

We have no control over the quality or correctness of equipment installations performed by others, nor can we control the uses (in manner or environment) products are subjected to. Accordingly, liability on the part of EPAS Performance LLC is limited to the terms of its Express Limited Warranty.

A decision by the purchaser to retain and install the item purchased will be deemed acceptance of the specific terms of this Liability Limitation and Release.

The purchaser expressly releases and waives any claim against us for any consequential damages or injury that may arise from the use, or any malfunction, of its product. This Liability Limitation and Release binds the original purchaser, all successors in interest, and all persons to whom the product may subsequently be transferred; and the purchaser agrees to make this limitation known to all such persons. This Liability Limitation and Release is part of the consideration for the sale of the product.

This Liability Limitation and Release is governed by the laws of the State of Florida, United States of America. Any dispute regarding its terms or application is subject to arbitration in the State of Florida at the request of either party to the sale.

## WARRANTY

This warranty is limited to the repair or replacement of the defective part only; the warranty specifically excludes labor or consequential damages or injury. The decision as to whether the defective part will be repaired or replaced will rest solely with the manufacturer. The warranty period begins on the date the product is shipped to you.

Full 5-year warranty nontransferable.

This warranty is void if the product is or was improperly installed, abused in any manner. Road or accident damage is not covered.

To make a claim under this warranty, call EPAS Performance to return the defective product, shipping or postage prepaid. Please include a copy of the original purchase invoice and a note describing the circumstances of the failure or malfunction.

This warranty is governed by the laws of the State of Florida, United States of America. Any dispute regarding the coverage of this warranty, its application or terms is subject to arbitration in the State of Florida.

If the purchaser disagrees with any of the terms of this warranty, please return the purchased item within three (3) business days of receipt. A decision by the purchaser to retain and install the item purchased will be deemed acceptance of the specific terms of this warranty.

1/16/2020

**Thank you for purchasing the EPAS Performance electric power system.  
We do hope you enjoy your vehicle for many miles to come.**

